

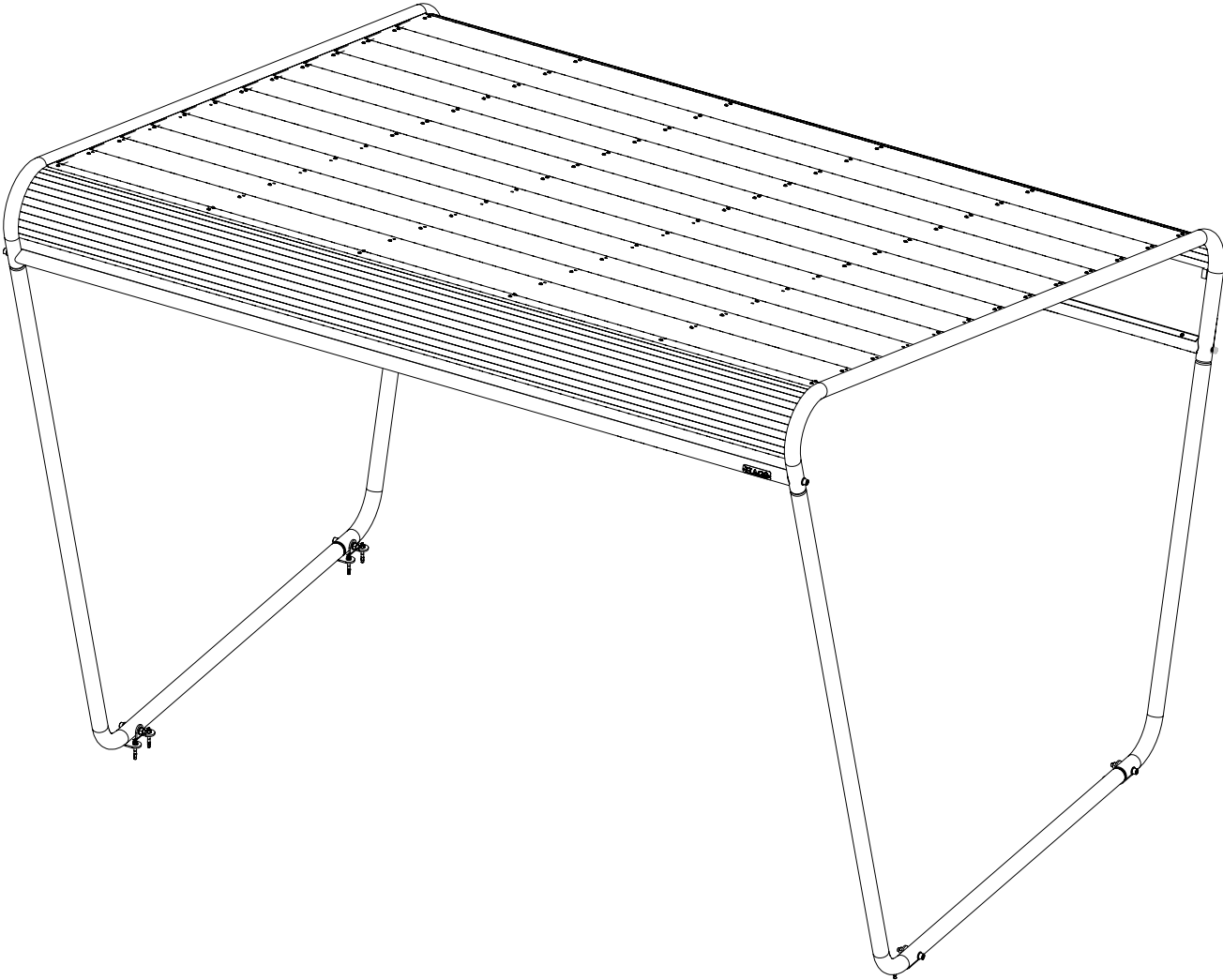











Atria Cycle Shelter

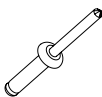









MASW88101



OM



1	SW85199		2x 2826mm	10.10kg
2	SW88242		1x 2817x69x460mm	13.15kg
3	SW88243		1x 2817x69x460mm	13.15kg
4	8008904		2x Blind rivet, 4x8-A2/A2-(2.5-4.5)	0.00kg
5	8008753		26x DIN986-M8-8	0.008kg
6	8027762		168x M6x25-8.8-(ISO7380)	0.006kg
7	SW87638		1x 100x30x6mm	0.04kg
8	SW88232		13x 2824x50x26mm	6.73kg
9	SW98944		2x 2480x22x5mm	0.47kg
10	SW88259		1x 2798x270x256mm	14.51kg
11	SW88260		1x 2798x378x206mm	17.56kg
12	8008497		4x ISO4762-M12x80-8.8	0.090kg

13	8008478		26x ISO4762-M8x60-8.8	0.031kg
14	8035699		12x ISO7089-13x24x2.5	0.006kg
15	8050049		52x ISO7089-8.4x16x1.6	0.002kg
16	8008557		8x Expansion anchor M8x71 HDG	0.08kg
17	8008772		4x Nut, ISO4032-M12-8	0.017kg
18	SW87947		2x 1356x573x51mm	5.38kg
19	SW87948		2x 3045x1111x51mm	13.12kg
20	SW88479		4x 124x68x50mm	0.29kg
21	8008497		4x ISO4762-M12x80-8.8	0.090kg
22	SW92073		12x 2798x265x3.5mm	8.72kg

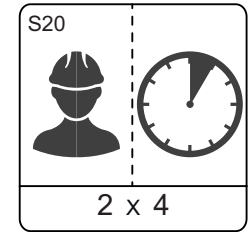
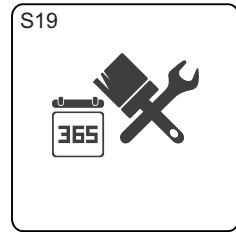

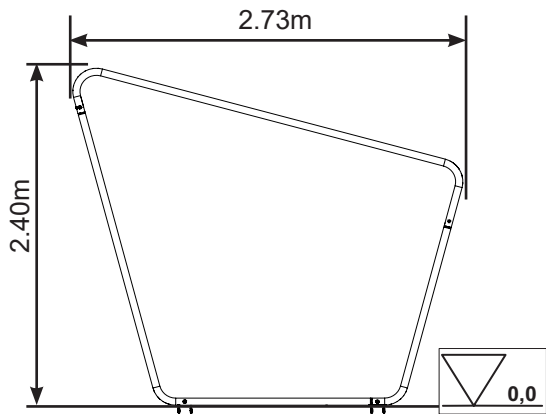

S11

Nm

M8 24Nm

S11

Nm

M12 81Nm

